



LAGUNA

151-CFlux3Tv2

CFlux 3 mod.2022 Cyclone Dust Collector 400V

Manual



Producer

Laguna Tools Inc.

744 Refuge Way, Suite 200 Grand Prairie, Texas 75050

USA

Phone: +1 800-234-1976

Website: www.lagunatools.com

Distributor

IGM nástroje a stroje s.r.o.

Ke Kopanině 560, 252 67, Tuchoměřice

Czech Republic, EU

Phone: +420 220 950 910

E-mail: sales@igmtools.com

Website: www.igmtools.com

2024-08-26

151-CFlux3Tv2 LAGUNA Cyclone Dust Collector Manual EN v6.01.00 A4ob
VZOR_Návod k obsluze STROJ EN v1.00.00



EN – English Manual

Dear customer,

thank you for the confidence you have placed in us with the purchase of your new Laguna machine from IGM. This manual was prepared for the owner and operator of **IGM LAGUNA CFlux 3 mod.2022 Cyclone Dust Collector 400V** to promote safety during setup, operation and maintenance. Please read carefully and understand the information contained in this manual and accompanying documents. To obtain maximum service life and performance, use the machine according to these instructions and safety guidelines. Observe work safety.

We wish you a lot of work satisfaction and joy when working with the IGM LAGUNA CFlux 3 mod.2022 Cyclone Dust Collector 400V.

Contents

1. Declaration of Conformity
 - 1.1 Warranty
2. Product Specifications
3. Safety
 - 3.1 Intended Use
 - 3.2 General Safety Instructions
 - 3.3 Symbols
 - 3.4 Additional Instructions for Dust Collectors
 - 3.5 Power Supply
 - 3.6 Environment
4. Machine Description
 - 4.1 Package Contents
 - 4.2 Parts Description
5. Setup
 - 5.1 Unpacking
 - 5.2 Assembly
 - 5.3 Operation
6. Maintenance and Inspection
 - 6.1 Emptying the Drum
 - 6.2 Emptying the Filter Waste Bag
 - 6.3 Cleaning the Filter
 - 6.4 Replacing the Filter
7. Accessories
8. Troubleshooting
9. Wiring
10. Parts List

1. Declaration of Conformity



EC DECLARATION OF CONFORMITY

According to the following EC Directives

- Machinery Directive: 2006/42/EC
- Low Voltage Directive: 2014/35/EU



The applicant: LAGUNA TOOLS, INC./ 744 Refuge Way, Suite 200, Grand Prairie, Texas 75050 USA

Manufacturer: SAN FORD MACHINERY CO., LTD./ No.169, Chung shan Rd., FengYuan Dist., Taichung City 420, Taiwan (R.O.C.), Taiwan, manufacturer, declares that the machine described hereafter:

DUST COLLECTOR MODEL:

BFLUX1, CFLUX1, PFLUX1, CFLUX2, PFLUX2, CFLUX3, PFLUX3, TFLUX5, TFLUX10, XFLUX10, SFLUX10, AFLUX12, 820680, 821200

Provided that it is used and maintained in accordance with the generally accepted codes of good practice and the recommendations of the instructions manual, meets the essential safety and health requirements of the Machinery Directive.

The person who compile technical file established within the EU:

Name: IGM nastroje a stroje s.r.o.

Address: Ke Kopanine 560, Tuchomerice, CZ-252 67

Tel.: +420 220 950 910

Email: sales@igmttools.com

The TCF (No. SF-2024003-A1) is archived by CEPROM S.A. located in Str. Fântânele f.n., 440240 Satu Mare, judetul Satu Mare, Romania.

For the most specific risks of this machine, safety and compliance with the essential requirements of the Directive has been based on elements of:

- **EN ISO 12100:2010 / Safety of machinery - General principles for design - Risk assessment and risk reduction (ISO 12100:2010)**
- **EN 60204-1:2018 / Safety of machinery - Electrical equipment of machines- Part 1: General requirements- Industrial electrical device.**



Date: May 20, 2024

Authorized Signature:

Position: Chief Executive Officer

Place: Laguna Tools Inc.

744 Refuge Way, Suite 200, Grand Prairie, Texas 75050, USA

1.1 Warranty

IGM always strives to deliver a high-quality and efficient product. The warranty is governed by the valid terms and conditions of IGM.

2. Product Specifications

Machine Dimensions (LxWxH):	1168 x 686 x 2286 mm
Machine Weight:	169 kg
Package Dimensions (LxWxH):	1300 x 800 x 1270 mm
Package Weight:	176 kg
Noise Level:	88 dB
Motor:	2200 W
Power:	400 V / 50 Hz / 3 Phase
Recommended Breaker:	16 A, tripping characteristic C (16/3/C)
Airflow (traditional method):	3831 m ³ /hour (2253 CFM)
Airflow (realistic method):	2209 m ³ /hour (1299 CFM)
Max. Static Pressure:	2800 Pa
Fan Diameter:	390 mm
Inlet Diameter:	1x 200 mm or 3x 100 mm
Switch:	High-frequency remote control switch
Drum Volume:	174 l
Filter:	99.97 % of particles over 1 micron
Filtered Area:	9,5 m ²
Filter Dimensions:	diameter 400 mm x height 900 mm
Filter Waste Bag:	660 x 620 mm
Drum Waste Bag:	1194 x 960 mm

3. Safety

Proper use includes compliance with the instructions given in this manual and general regulations applicable in your country. The operator is liable for any use in violation of the intended use.

3.1 Intended Use

The machine is designed for collecting chips and sawdust from wood and woodworking machines. Collection of any other materials is prohibited.







3.2 General Safety Instructions

Warning! Read all instructions and safety guidelines. Failure to follow safety instructions may result in damage to the machine and serious injury to the operator. Keep the manual for future reference.

- The machine may be dangerous if not used properly.
- The machine may be operated only by a person familiar with the contents of this manual and machine operation.
- Keep children and pets away from packaging materials supplied with this machine.
- Place the machine on a stable and well-lit surface. There must be sufficient space around the machine for safe operation.
- Check the technical condition of the machine before operation. The machine may be used only in a perfect technical condition. If you notice any defects, do not start the machine and have it repaired by a qualified person.
- Replace damaged parts immediately. Use only original spare parts.
- All safety covers must be mounted before operation. Replace damaged covers immediately.
- The machine may be used, assembled, and maintained only by persons familiar with its operation and aware of potential danger. No changes to the machine may be made!
- Carry out maintenance regularly.
- Keep the machine and the surrounding area clean and well-lit. Remove all tools from the machine and surroundings before starting the machine.
- Carry out assembly, repairs and maintenance only when the machine is disconnected from the power supply.
- Prevent unintentional start of the machine. Before connecting the machine to the power supply, make sure the switch is in the OFF position.
- Make sure the circuit requirements specified in this manual are met.
- Take care of your safety when operating the machine. Long hair, loose clothing and jewellery may cause injury. Wear suitable work clothing, footwear, head, eye, ear and respiratory protection.
- Do not use gloves when operating the machine.
- Do not operate the machine if you are tired, ill or under the influence of drugs or alcohol.
- Watch your hands and fingers. Always use both hands when working.
- Do not lean over the machine. Always maintain balance and stand on a firm and stable surface when working.

- Keep children and other persons from moving freely around the workplace. Keep the machine out of reach of children and unqualified persons. Do not allow anyone unfamiliar with the machine and this manual to operate the machine.
- Never leave a running machine unattended. After you finish your work, turn off the machine and disconnect it from the power supply.
- Do not leave the machine in a damp environment and do not expose it to rain.
- Do not overload the machine.
- Do not operate the machine near flammable liquids or gases.
- Keep the motor fan clear.

3.3 Symbols

	Read the manual and all instructions carefully before use.
	Wear head, ear, eye and respiratory protection.
	Disconnect the machine from the power supply.
	Scan the QR code to find the manual.
	CE mark: The product is in compliance with EEA directives.
	Do not dispose of the appliance in the municipal waste.
	Recycle package materials.

3.4 Additional Instructions for Dust Collectors

Caution! Dust containing harmful chemicals such as lead from lead-based paints or arsenic and chromium from chemically treated lumber can be produced during operation. Work in a well-ventilated area and wear approved protective equipment. Observe safety regulations applicable in your country.

- Wear eye and respiratory protection when operating and maintaining the machine.
- Dispose of waste (dust and chips) following local regulations applicable in your country.
- Make sure the casters are locked before turning the machine on.
- Do not place your hands or tools near the air intake.
- Collect intended material only. If you accidentally use wood containing metal scraps (nails, staples etc.), stop working and turn the machine off immediately. Empty the drum (bag) and check the condition of the machine.
- Regularly check the waste level in the drum (bag). Empty if necessary.

3.5 Power Supply

Warning! Any modification to the electrical installation may be carried out only by a qualified electrician in accordance with all applicable regulations.

Warning! Do not connect the machine to the power supply until it is ready for operation.



Circuit Requirements

Warning! These requirements apply to a dedicated circuit where only one machine runs at a time. Consult a qualified electrician before connecting the machine to a shared circuit. Make sure the circuit is properly sized for safe operation.

This machine is designed to operate on a grounded power supply. The power circuit includes all electrical appliances between the machine and the breaker box or fuse panel in the building. The power circuit used for this machine must be sized to safely handle a full load current for an extended time.

Grounding and Plug Requirements

Caution! Improper grounding and connection of the machine to the power supply may result in an electric shock, damage or fire.

This machine is equipped with a grounded power cord. Insert the plug only into a matching outlet that is properly installed and grounded in accordance with all local regulations. Do not modify the provided plug!

Do not use the machine if the power cord or plug is damaged. All repairs may be carried out only by a qualified electrician!

3.6 Environment

Do not dispose of the appliance in the municipal waste. Electronic appliances must be collected and handed in for proper recycling. Recycle package material and other accessories. Observe safety regulations applicable in your country.



4. Machine Description

Carefully observe the images below and familiarize yourself with the package contents and listed machine parts and features.

4.1 Package Contents

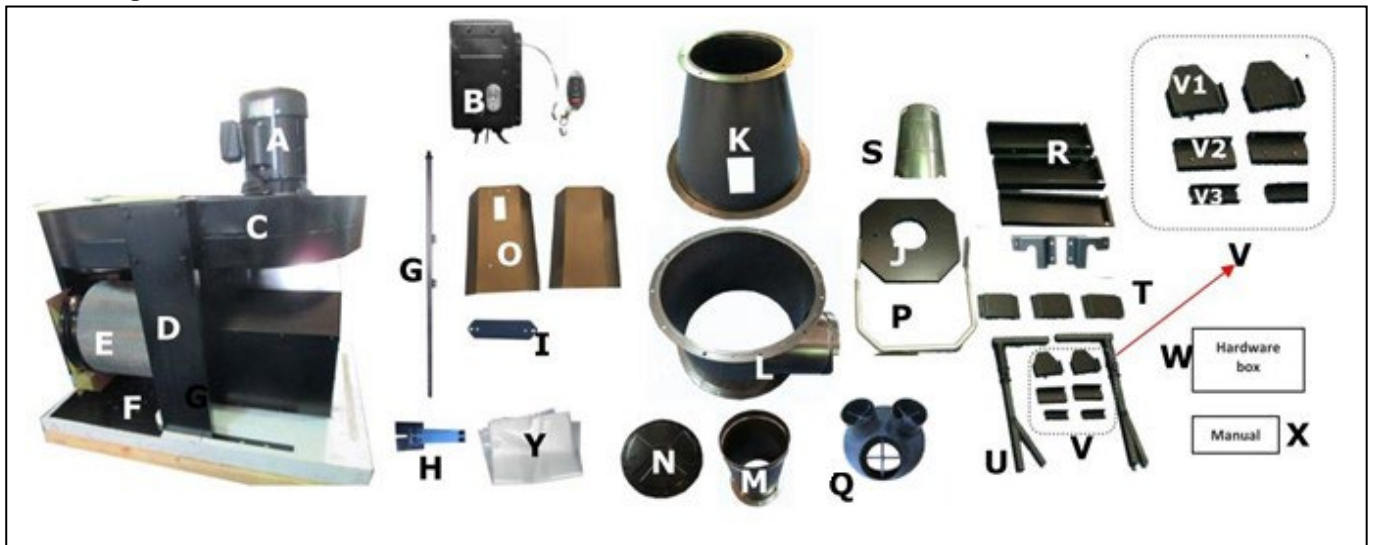

- A. Motor
- B. Control panel and remote control
- C. Dust chute
- D. Top upright supports (3x)
- E. Filter 1 micron
- F. Base frame
- G. Rotation shaft
- H. Rotation paddle (2x)
- I. Crossbar
- J. Drum lid
- K. Cyclone funnel
- L. Cyclone barrel
- M. Intake cylinder
- N. Filter cover
- O. Front and back drum panel
- P. Handle for drum lifting
- Q. Inlet adaptor (3 openings)
- R. Lower upright supports (3x)
- S. Drum insert
- T. Upright support reinforcement plate (3x)
- U. Right and left bar for lifting mechanism
- V. Accessories to install the lifting mechanism
 - V1. Lower triangular support plate (2x)
 - V2. Lifting mechanism support (2x)
 - V3. Lower support plate (2x)
- W. Hardware
- X. Manual

- X. Manual
- Y. Waste bags

4.2 Parts Description

Control panel

- A. On board circuit breaker
Pops out if the machine is overloaded. Allow the machine to cool down for a few minutes. Then press the reset button.
- B. Power cord
- C. ON/OFF switch
Turns the collector on or off.
- D. Motor power cord
- E. Control panel pair button
Used to pair remote control with the machine.

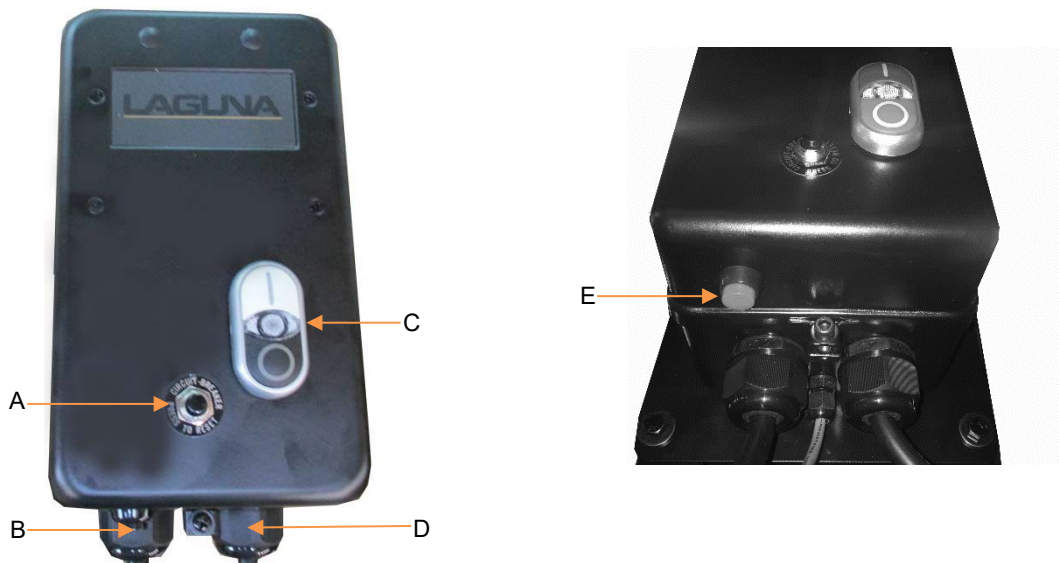

Remote control

The remote control requires a 12V battery type 27A.

- A. ON button
- B. OFF button
- C. CLEAN button (PFlux only)
- D. Remote control pair button



Pairing remote control

1. Ensure the machine is ON before pairing the remote control.
2. Press the control panel pair button until you hear two beeps.
3. Press the remote control pair button simultaneously with the control panel pair button until you hear three beeps. The remote control is now paired.

Pairing more remote controls

You can pair up to 5 remotes to one machine. Each remote must be paired separately. If you pair a sixth remote to the machine, the first paired remote will be disconnected and replaced by the sixth remote. This also applies to the next remotes.

5. Setup

Approximate assembly and setup time: 4-5 hours

5.1 Unpacking

When unpacking, separate the machine and all supplied parts from the packaging materials. Check that no parts have been damaged. If damage has occurred as a result of transport, contact your supplier immediately.

The dust collector is supplied in a single box. Two persons are required to remove the machine from the box! The collector is heavy, be careful when lifting and moving.

1. Carefully cut the banding straps.
2. Cut along the tape line at the top of the box.
3. Remove all parts from the top of the polystyrene and set aside.
4. Remove the polystyrene packing material from the top of the machine.
5. Carefully take out the machine components from the box and set aside.
6. Check all parts according to package contents.

5.2 Assembly

Required tools (not supplied):

- Wrench – 10 mm; 12 mm; 14 mm
- Phillips screwdriver
- Hex key - 4 mm; 5 mm
- Silicone

Step 1: With the help of another person, remove the dust chute from the package. Turn it upside down and place it in the polystyrene packing.



Step 2: Remove base frame that is bolted to (3x) top upright supports. Keep (6x) 3/8"x3/4" bolts and (6x) 3/8" washers.

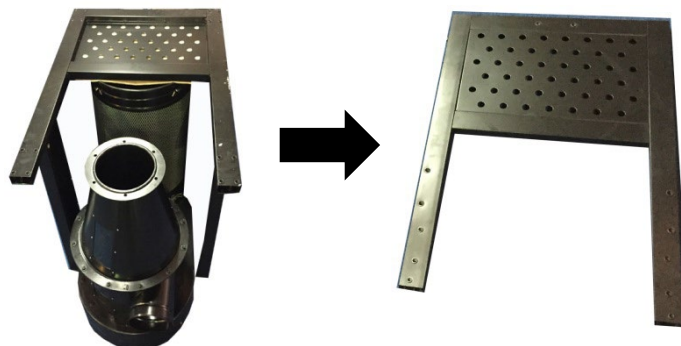

Step 3: Prepare (16x) 5/16 "x3/4" bolts and (16x) 5/16" washers. Install two casters with brakes (B) to the part of the base with the drum opening and the other two casters (A) on the opposite side of the base.



Step 4: Turn the base over with it standing on the casters. Mount the (3x) lower upright supports (top of triangles pointing inside) to the base using (6x) 3/8"x3/4" bolts and (6x) 3/8"x7/8" flat washers.

A - mount the support with one triangle on the filter side.

B - mount the support with two triangles on the front side.

C - mount the support with three triangles on the opposite side.

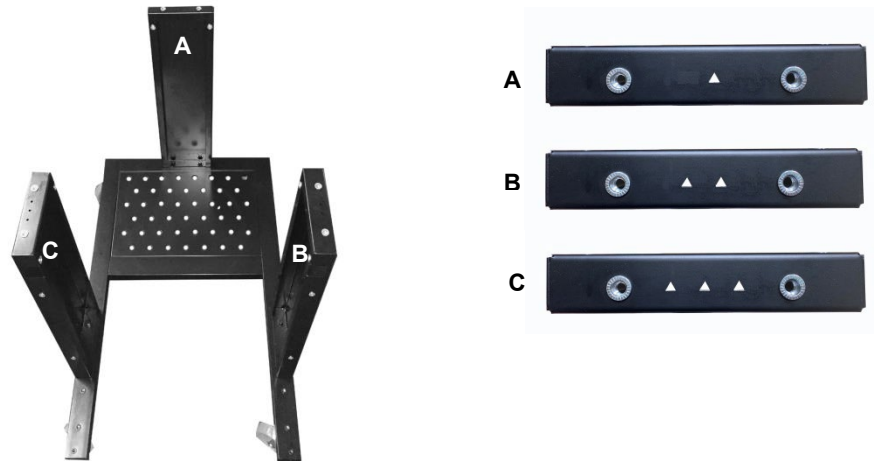

Step 5: Apply 3x6mm foam tape to the upper and lower rims of the following three components: intake cylinder (top rim), cyclone barrel (top rim), cyclone funnel (top and bottom rim).

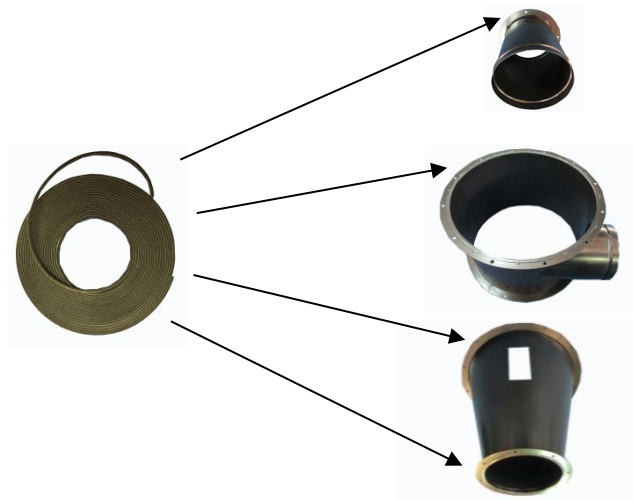

Step 6: Attach the intake cylinder to the dust chute with (4x) 5/16"x5/8" bolts and (4x) 5/16" washers. Then attach the cyclone barrel to the dust chute using (12x) 5/16"x3/4" bolts and (12x) 5/16" washers. Next, attach the cyclone funnel to the dust chute using (12x) 5/16"x3/4" bolts, (24x) 5/16" washers and (12x) 5/16" nuts. Make sure the cyclone funnel is positioned correctly. The inlet adapter mount hole is on the right side (A) when upside down. The inlet adapter mount hole is on the left side (B) when in operating position.

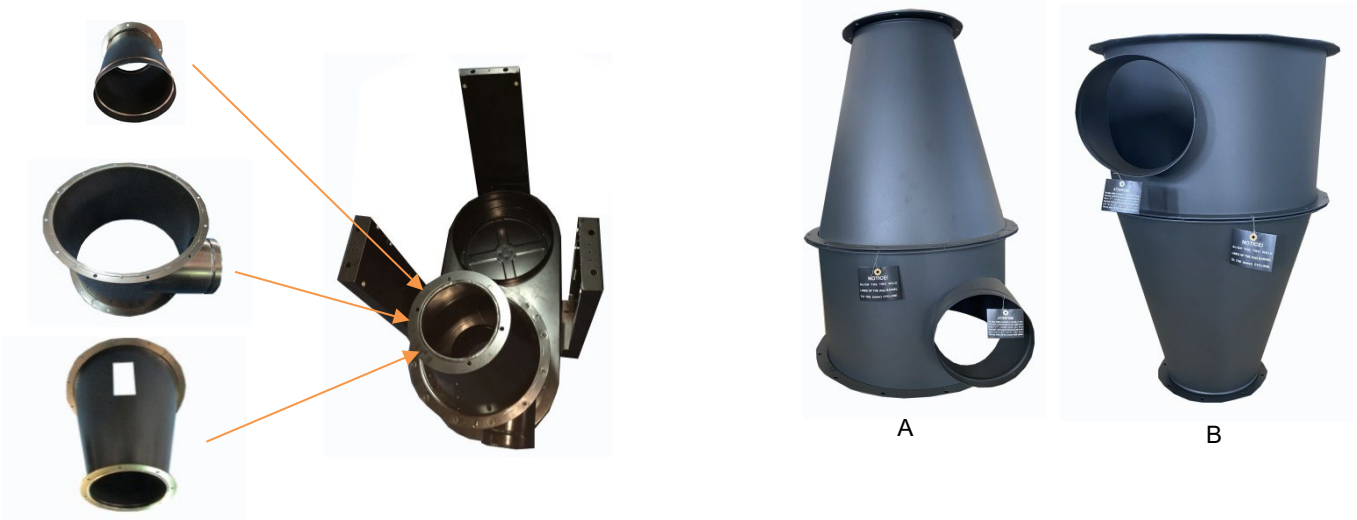

Step 7: Secure the base with lower upright support panels to the dust chute. Make sure the top and lower supports match. Use (6x) 5/16"x3/4" bolts and (6x) washers to connect the top and lower supports.



Step 8: Secure (3x) upright support reinforcement plates where the top and lower upright supports meet using (12x) 5/16"x3/4" bolts and (12x) 5/16" washers.

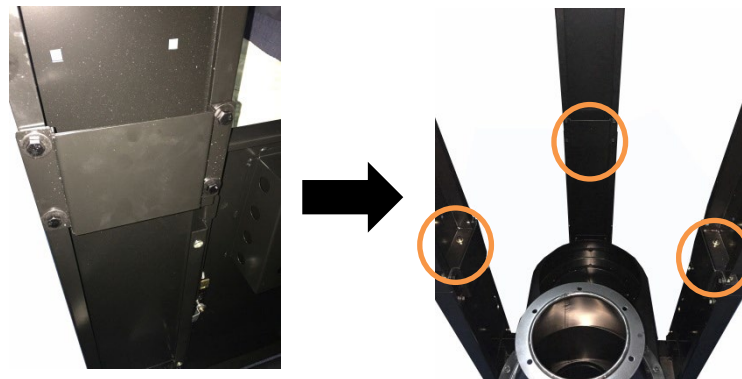

Step 9: With the help of another person, turn the collector over with it standing on the casters.

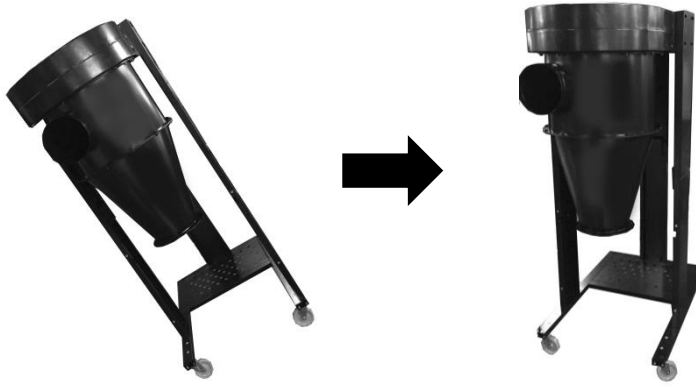

Step 10: Apply foam tape to the edge of the plate (between the edge and screw holes). Attach the filter cover to the dust chute using (12x) 3/16"x1/2" sheet metal screws.

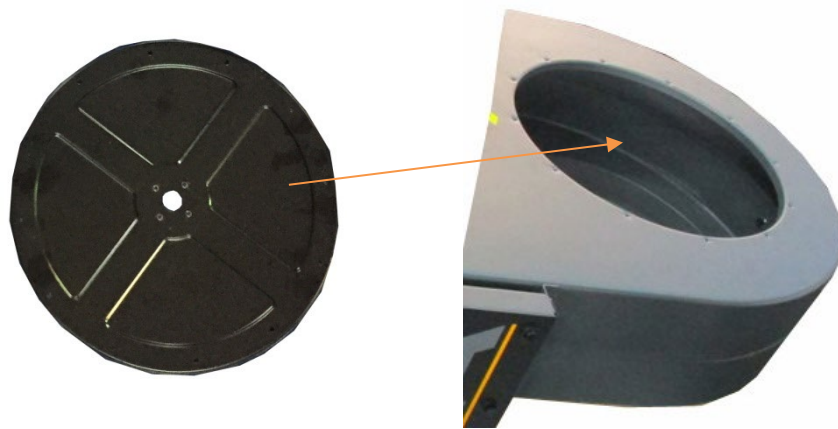

Step 11: Attach the (2x) rotation paddles to the rotation shaft using (4x) 1/4"x5/8" screws, (8x) 1/4" washers a (4x) 1/4" nuts.

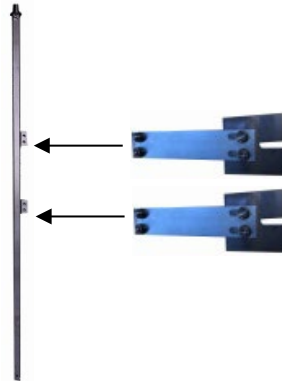

Step 12: Insert the rotation shaft assembly into the filter. It will be easier to insert while holding it at an angle. Insert the bottom end of the shaft into the hole in the bottom of the filter.

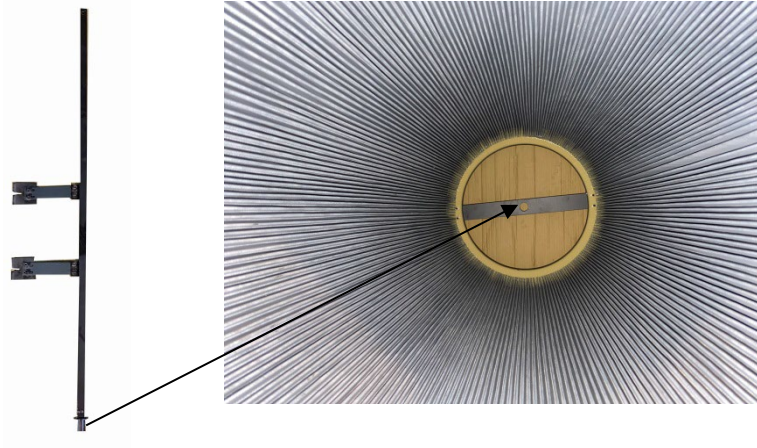

Step 13: With the help of another person holding the filter, take the rotation shaft and push through the hole in the middle of the filter cover. Make sure to hold the shaft above the cover.

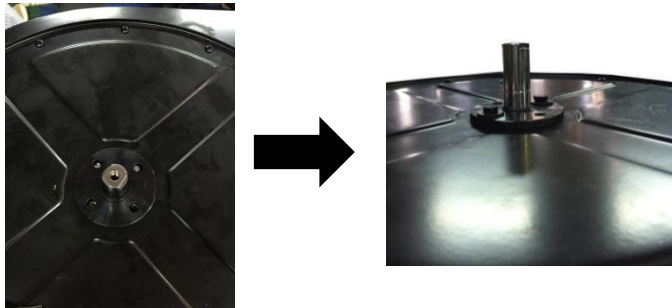

Step 14: While your assistant is holding the rotation shaft above the cover, attach the filter to the dust chute using the band clamp at the top of the filter. Ensure the filter is tightly fitted onto the dust chute.



Step 15: Insert the bearing onto the rotation shaft. Secure the bearing using (4x) 1/4"x3/4" bolts and (4x) 1/4" washers. You no longer need to hold the rotation shaft.

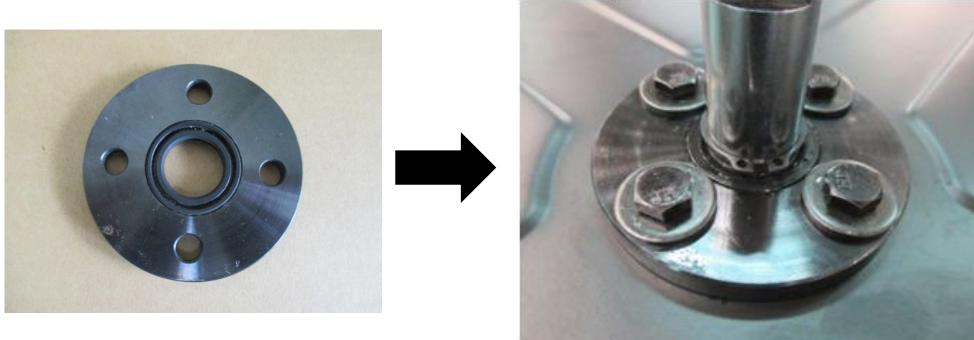

Step 16: Attach and secure the rotation crank to the rotation shaft using (1x) 5/16"x3/4" bolt and (1x) 5/16" washer.

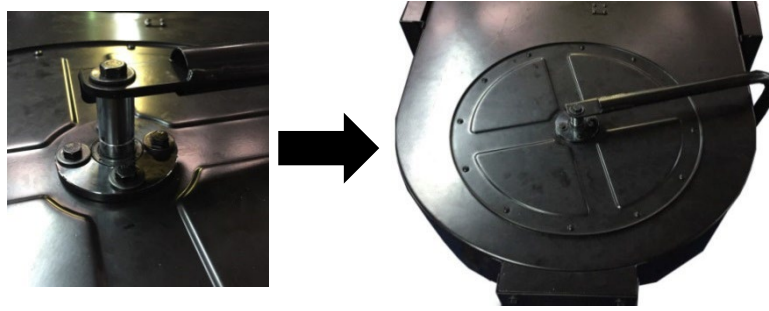

Step 17: Tighten the (1x) 5/16"x3/4" screw and (1x) 5/16" washer on the bottom of the rotation shaft.



Step 18: Secure the lower triangular support plate to the base using (2x) 5/16"x3/4" bolts and (2x) 5/16" washers. Follow the same steps for the opposite side.



Step 19: Secure the lifting mechanism support to the lower upright support using (2x) 5/16"x1/2" bolts, (2x) 5/16" washers and (2x) 5/16" nuts.



Step 20: Find the left (A) and right (B) bar for lifting mechanism. To identify the correct side, look for the protruding nut. It should be facing upwards when you place the bars on the floor.

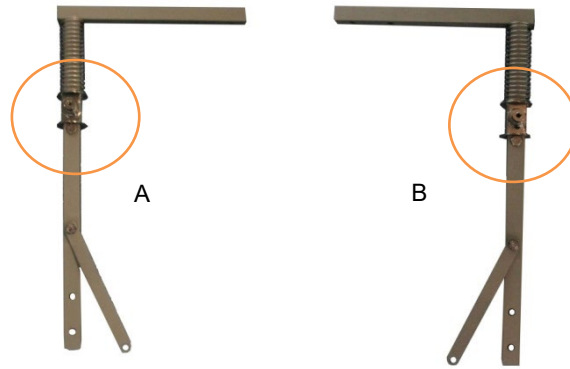

Step 21: Slide the bar into the opening on the lower upright support. Follow the same steps for the opposite side.



Step 22: Make sure the bar is pushed all the way into the opening on the lower upright support. Secure the bar using (4x) 5/16"x1-3/4" bolts, (8x) 5/16" washers and (4x) 5/16" nuts. Follow the same steps for the opposite side.

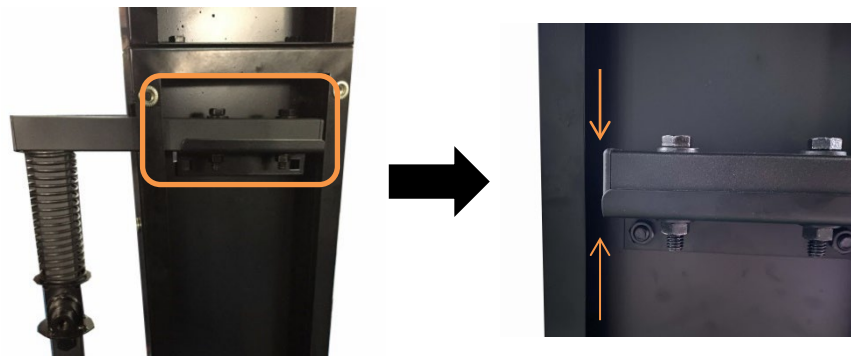

: Secure the U-channel (A) to the triangular support plate using (2x) 5/16"x1-3/4" bolts, (4x) 5/16" washers and (2x) 5/16" nuts so that the bolt head is on the inside (B). Follow the same steps for the opposite side.

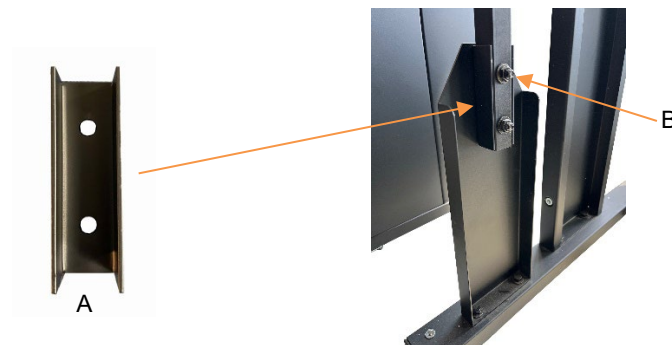

Step 24: Attach both ends of the handle for lifting drum to the nut of the lifting mechanism.

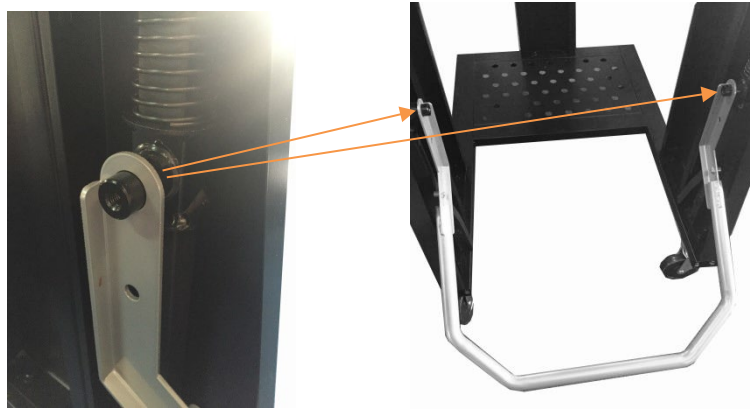

Step 25: Secure with cover. Cover is attached using (1x) M8x30 mm bolt. Follow this step on the opposite side.

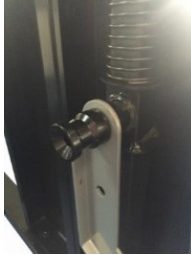

Step 26: Secure the bar to the handle using (2x) 3/8"x21mm bolts and 3/8" nuts. Make sure the bolt head is on the inside of the handle (A). Adjust the tightness of this bolt accordingly. If this bolt is too tight, the lifting mechanism will not work smoothly. When too loose it will not pick up the drum.



Step 27: Attach the drum lid to the cyclone funnel with applied foam tape using (6x) 5/16"x3/4" bolts, (12x) 5/16" washers and (6x) 5/16" nuts. On the funnel you will find the following label:
ATTENTION! Do not tighten the (8x) bolts that mount the cyclone funnel to the drum lid. First, perfectly align the drum lid parallel to the upright supports. The drum lid can be swivelled about 30 degrees +/- . Failure to do so will make the drum poorly sealed and unable to fit between supports. Remove this label after completing this step.



○

ATTENTION

Do not tighten the 8 X bolts that mounts to cone flange to top of drum lid until you have perfectly aligned the drum lid up parallel to the uprights.

This ingenious design allows you to swivel the drum lid about 30 degrees +/-

Failure to do so will make the drum unable to fit in space between vertical uprights.

Step 28: Attach the crossbar to the drum lid and tighten using (2x) 5/16"x3/4" bolts, (4x) 5/16" washers and (2x) 5/16" nuts. It does not matter which position you attach the crossbar.

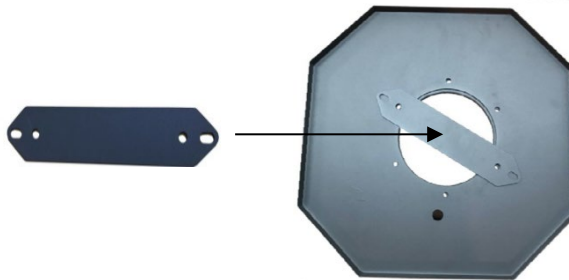

Step 29: Assemble the drum. Find the drum base panel and secure the (4x) casters using (16x) 5/16"x3/4" bolts, (32x) 5/16" washers and (16x) 5/16" nuts.

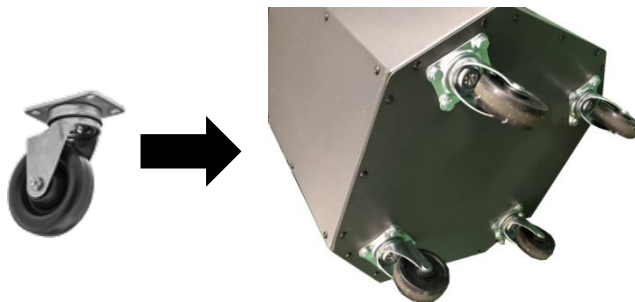

Step 30: Attach the handles to the top and bottom end on the front drum panel using (4x) 5/16"x3/4" bolts, (4x) 5/16" washers and (4x) 5/16" nuts. Note that the head of the bolt must be inserted from the handle with the nut and washer on the inside of the drum.



Step 31: Assemble front and back drum panel using (12x) M4x12mm sheet metal screws.

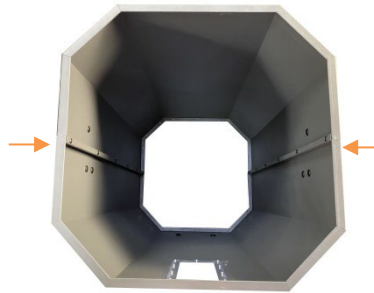

Step 32: On the left and right side of the drum you will find three bolt holes. Secure the matching side plate to the drum panel using (6x) 1/4"x1/2" bolts, (6x) 1/4" washers and (6x) 1/4" nuts. Insert the head of the bolt from the inside of the drum with the washers and nuts on the outside of the drum.

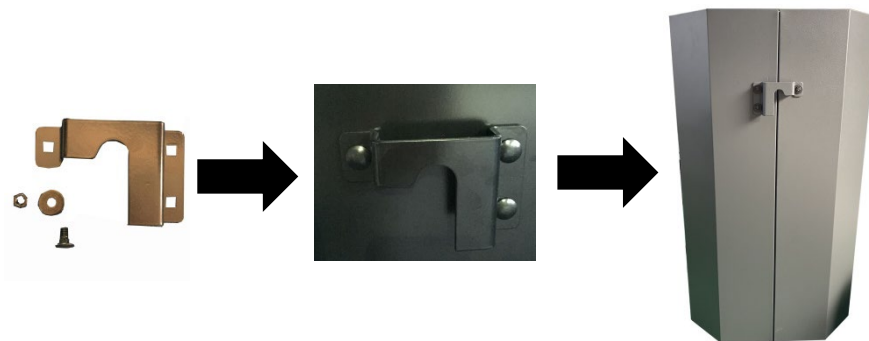

Step 33: Lay the drum on its side. With the help of another person, align the drum with the base with attached casters. Using (22x) M4 sheet metal screws fasten tightly.



Step 34: Cover all (22x) screws with (22x) plastic caps.



Step 35: Once assembly is complete, apply silicone (not included) to the top and bottom rim inside the drum. This will seal the drum and prevent any leaks.

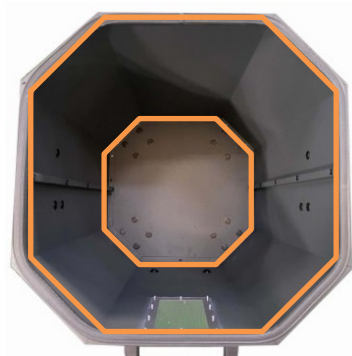

Step 36: Attach the rubber gasket to the top rim of the drum. Remove excess rubber gasket.

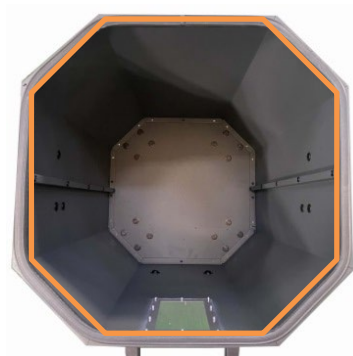

Step 37: Insert waste bag in the drum. Spread the bag all over the drum.



Step 38: Use (24x) 3/16"x1/2" bolts and (24x) 3/16" nuts to assemble the drum insert. Place the drum insert inside over the plastic bag.



Step 39: Lift the bar. Push the drum in and align. Lower the bar to seal the drum tight for normal machine operation.



Step 40: Make sure when aligning the drum that both the left and right side plates are seated in the lifting mechanism (A). When aligned incorrectly (B), the drum will not be fully sealed and will interfere with the airflow.

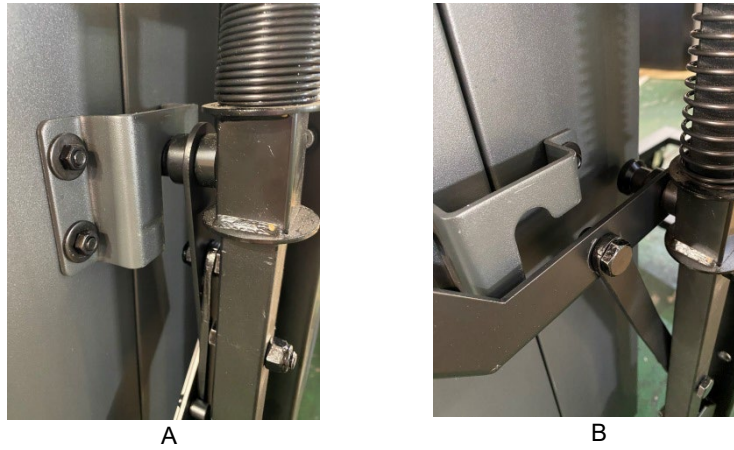

Step 41: Mount the control panel to the switch base plate using (4x) M4x6mm bolts.



Step 42: Install the control panel with base to the motor using (4x) 1/4"x3/4" bolts, (4x) 1/4" washers and (4x) 3/8" washers.



Step 43: Install the inlet adaptor with 3 openings using (3x) M4x12mm sheet metal screws. Attach the rubber caps to each opening. Assembly is now completed.



5.3 Operation

1. Remove the rubber cap from the connected opening. Check all parts of a dust collection system to ensure sufficient airflow.

Warning! Do not turn the collector on when all blast gates are closed!

2. Confirm that the power supply is connected correctly and without damage.
3. Check the surroundings. Do not carry out any repairs or maintenance on the machine when in use!
4. To start, press the ON button on either the control panel or paired remote control.
5. To stop, press the OFF button on either the control panel or paired remote control.

6. Maintenance and Inspection

Caution! Disconnect the machine from the power supply before maintenance and inspection. Carry out maintenance regularly.

Before each use, check for loose or damaged parts and whether the cord is worn out or damaged. Do not use the machine until all defects have been fixed. **After each use**, clean dust and other waste from the machine and surrounding area. Wipe the machine using a dry cloth.

Carry out the following tasks regularly:

- Check for leaks.
- Clean the filter and its parts.

6.1 Emptying the Drum

Periodically inspect the contents of the drum and empty as needed. To inspect the contents of the drum, look through the window or remove the drum.

1. Raise the handle for lifting drum to lower the drum on the floor.
2. Slide the drum out of the machine, check and empty as needed.

6.2 Emptying the Filter Waste Bag

Periodically inspect the filter waste bag. If it is more than one third full, empty it. If the filter bag gets too full, the weight may force it to pull down, exposing you to harmful particulates.

1. Release the band clamp at the bottom of the filter and remove the waste bag.
2. Empty or replace the bag and reattach.

6.3 Cleaning the Filter

Clean the filter by rotating the filter cleaner crank. This knocks the dust from the filter into the waste bag. We recommend cleaning the filter after each use of the machine.

1. Rotate the crank clockwise 4-5 times.

For heavy duty users, it is recommended to use compressed air regularly to maintain maximum filtration efficiency and longer service life. Turn the machine off and blow the filter from the outside using compressed air.

To clean the filter more effectively, remove it entirely:

1. Release the band clamp at the bottom of the filter and remove the waste bag.



2. Remove the screw on the rotation shaft at the bottom of the filter using 12 mm wrench.



3. Hold the filter from the bottom and release the band clamp at the top of the filter.

4. Remove the filter.

5. Use compressed air to thoroughly clean between the pleats, both inside and outside.

6. Reattach the filter to the machine.

6.4 Replacing the Filter

To maintain good air quality in your workshop and to ensure proper filtration, the filter should be replaced after approximately 2000 hours of operation (8 hours/day x 250 days = 2000 hours). Please contact your supplier for filter replacement.

7. Accessories

Recommended accessories is listed on the IGM website.

Caution! Installing unapproved accessories may cause damage to the machine and serious injury. Use only accessories recommended for this machine by IGM.

8. Troubleshooting

<p>Machine does not start or a breaker trips. Possible Cause:</p> <ol style="list-style-type: none"> 1) Power supply is turned OFF or faulty. 2) Wall fuse/circuit breaker is blown/tripped. 3) Faulty remote control. 4) Remote receiver is faulty. 5) Incorrectly wired motor connection. 6) On-board circuit breaker is tripped. 7) Wiring is open/has high resistance. 8) Faulty power switch. 9) Faulty switch. Motor is at fault. 	<p>Possible Solution:</p> <ol style="list-style-type: none"> 1) Ensure power supply is ON and has the correct voltage. 2) Ensure adequate circuit size, reset breaker. 3) Replace batteries; ensure unobstructed line of sight and signal range. 4) Inspect receiver circuit board; replace if faulty. 5) Rewire or call certified service technician or electrician. 6) Allow motor to cool, improve ventilation, press reset button. 7) Check for broken wires or poor connections, repair as necessary. 8) Replace switch. 9) Test/repair/replace.
<p>Excessive vibration or noise during operation. Possible Cause:</p> <ol style="list-style-type: none"> 1) Loose component. 2) Loose or broken motor mount. 3) Motor fan hitting fan cover. 4) Bad motor bearings. 	<p>Possible Solution:</p> <ol style="list-style-type: none"> 1) Inspect and tighten all bolts/nuts. 2) Tighten or replace as needed. 3) Check fan and cover; replace as needed. 4) Rotate shaft manually, check for grinding or loose shaft, replace bearings if needed.

<p>Loud or repetitive noise, excessive vibration coming from machine. Possible Cause:</p> <ol style="list-style-type: none"> 1) Machine is on uneven surface. 2) Damaged/Unbalanced fan. 3) Loose connections. 4) Fan is loose. 5) Motor fan hitting fan cover. 	<p>Possible Solution:</p> <ol style="list-style-type: none"> 1) Stabilize on a flat surface. 2) Inspect fan for dents, bends, or other damage. 3) Check and re-tighten all fasteners. 4) Replace the motor and fan. 5) Check fan and cover; replace as needed.
<p>Cyclone collector does not adequately collect dust or chips; poor performance. Possible Cause:</p> <ol style="list-style-type: none"> 1) Drum or filter waste bag are full. Filter is dirty. 2) Clogged dust collection. 3) Dust collection is too long or has too many sharp bends. 4) Wet lumber is clogging collection. 5) Leaks in the dust collection or too many open blast gates. 6) Inadequate velocity in the main collection line. 7) Wrong size ducting/ports used. 	<p>Possible Solution:</p> <ol style="list-style-type: none"> 1) Empty drum and filter waste bag. Clean filter. 2) Clean inlet adaptor. 3) Move the machine closer to the point of collection. Rerun ducts to eliminate sharp bends. 4) Use lumber with less than 20 % moisture content. 5) Repair all leaks and close any gates not being used. 6) Increase velocity by opening 1 or 2 more blast gates to different branch lines. 7) Re-size and re-install ducts and fittings.
<p>Sawdust being blown into the air from the cyclone collector. Possible Cause:</p> <ol style="list-style-type: none"> 1) Band clamps are not secure. 2) Loose or damaged seals. 	<p>Possible Solution:</p> <ol style="list-style-type: none"> 1) Re-install ensuring a tight fit. 2) Replace seals and gaskets.

Secondary control box

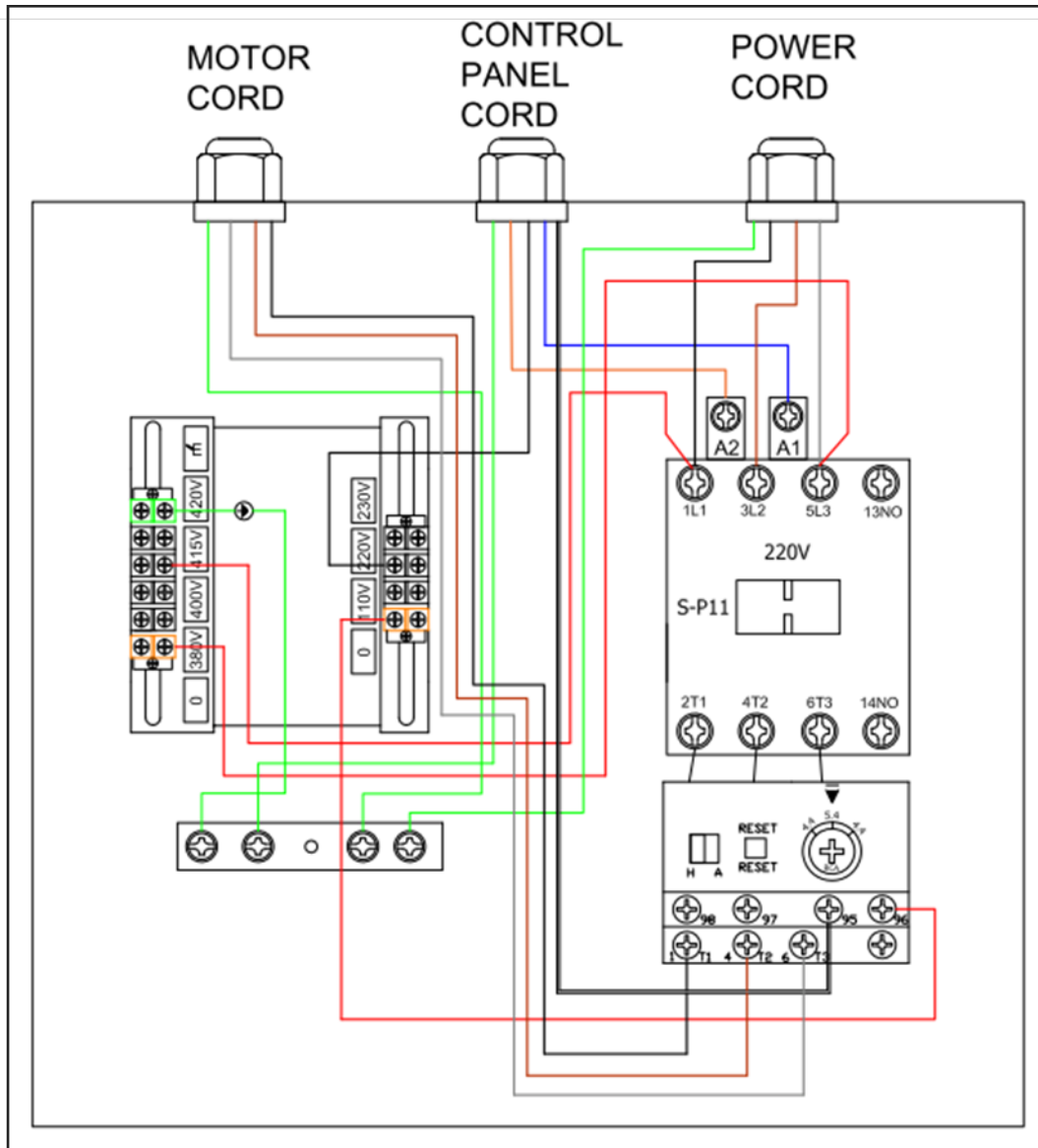

10. Parts List

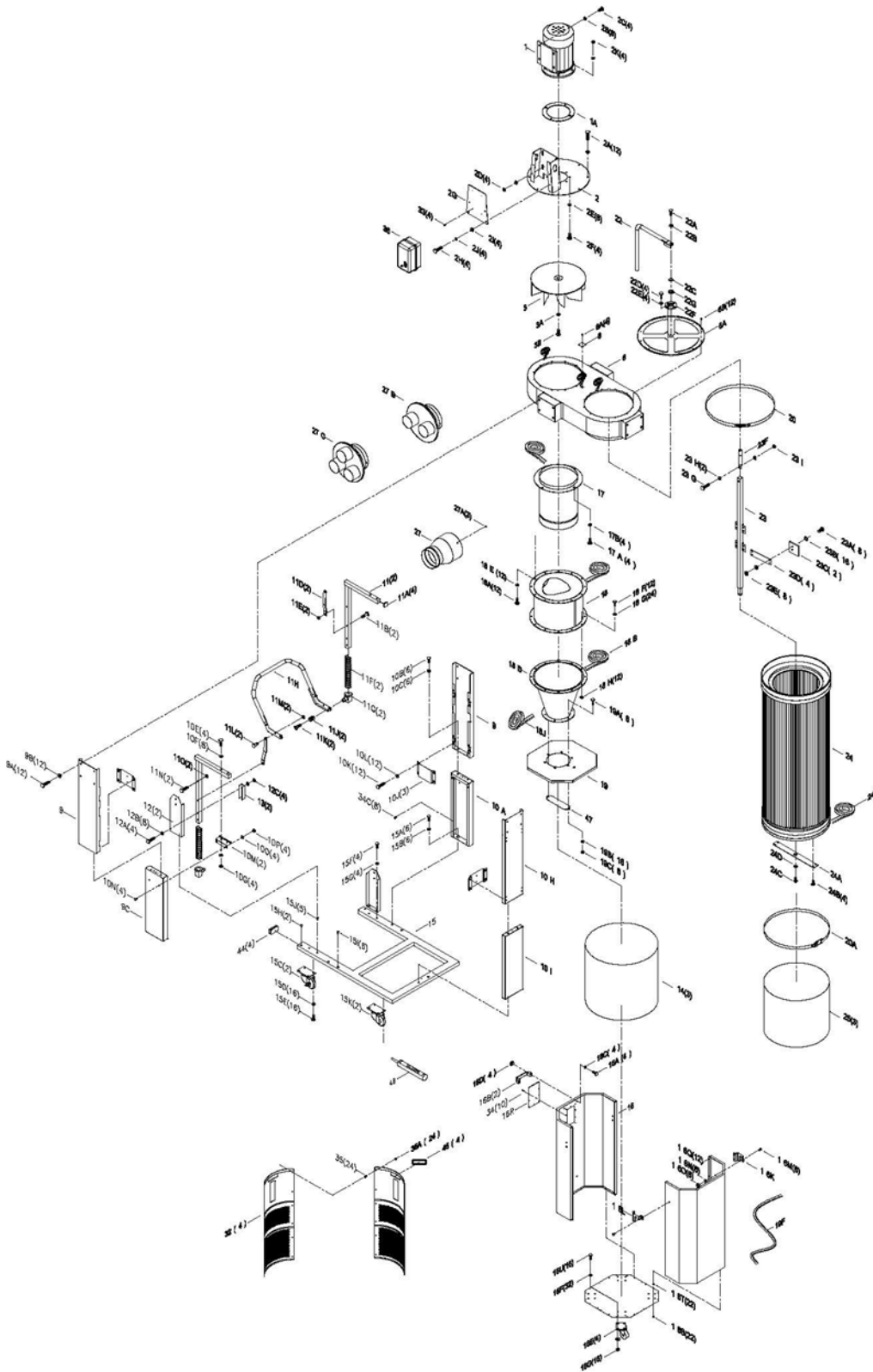

Fan, motor and switch

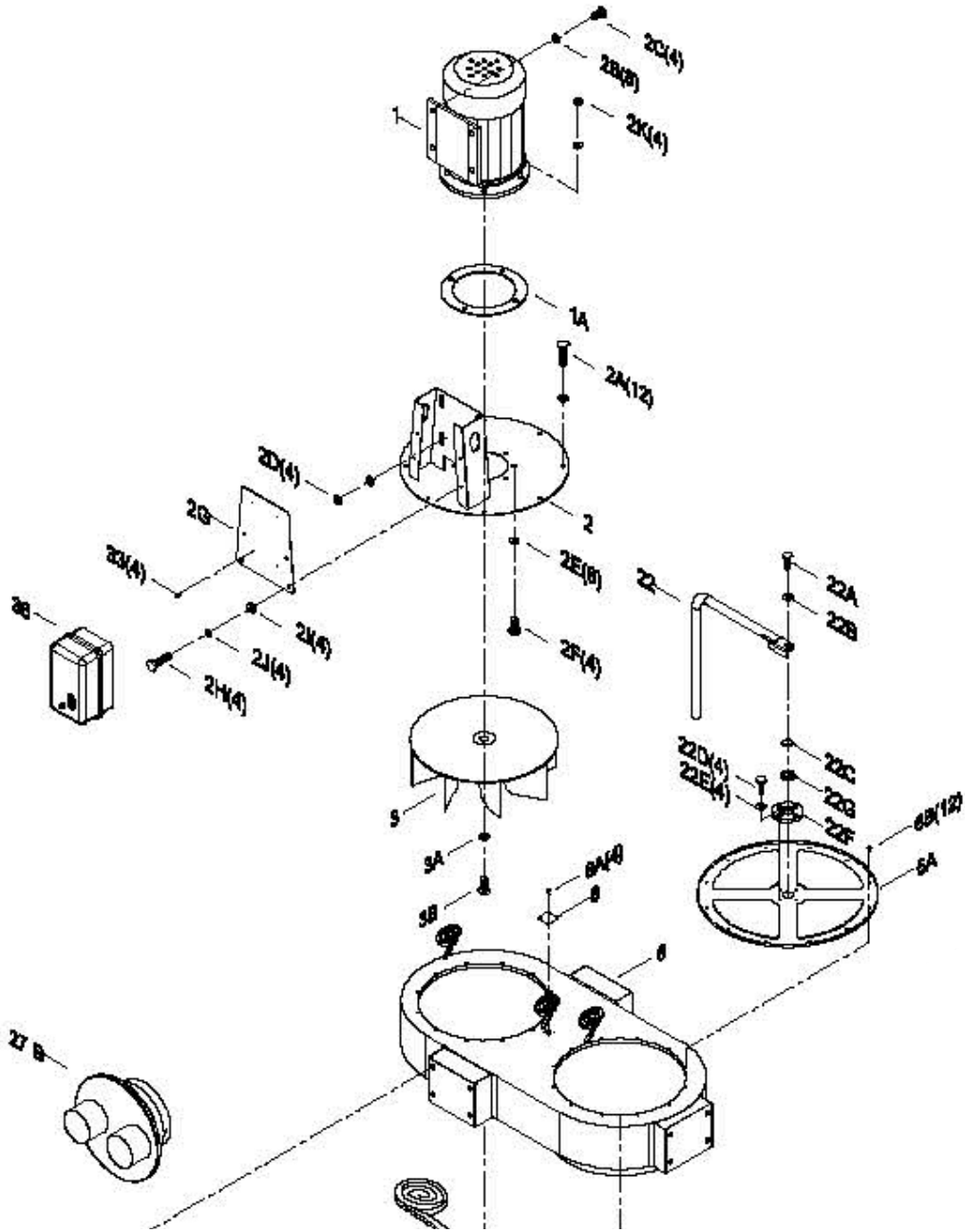

Cyclone and filter

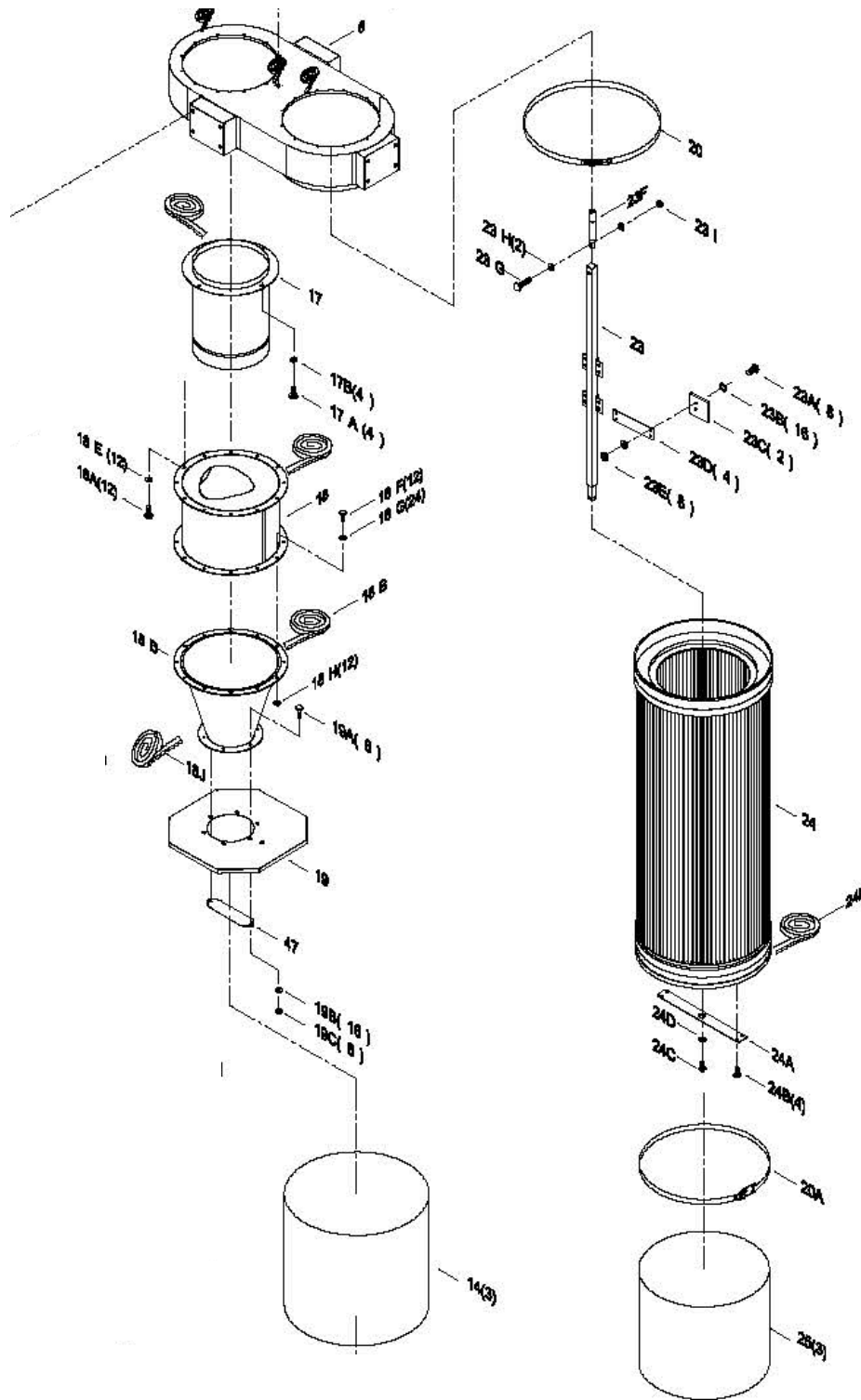

Lifting mechanism

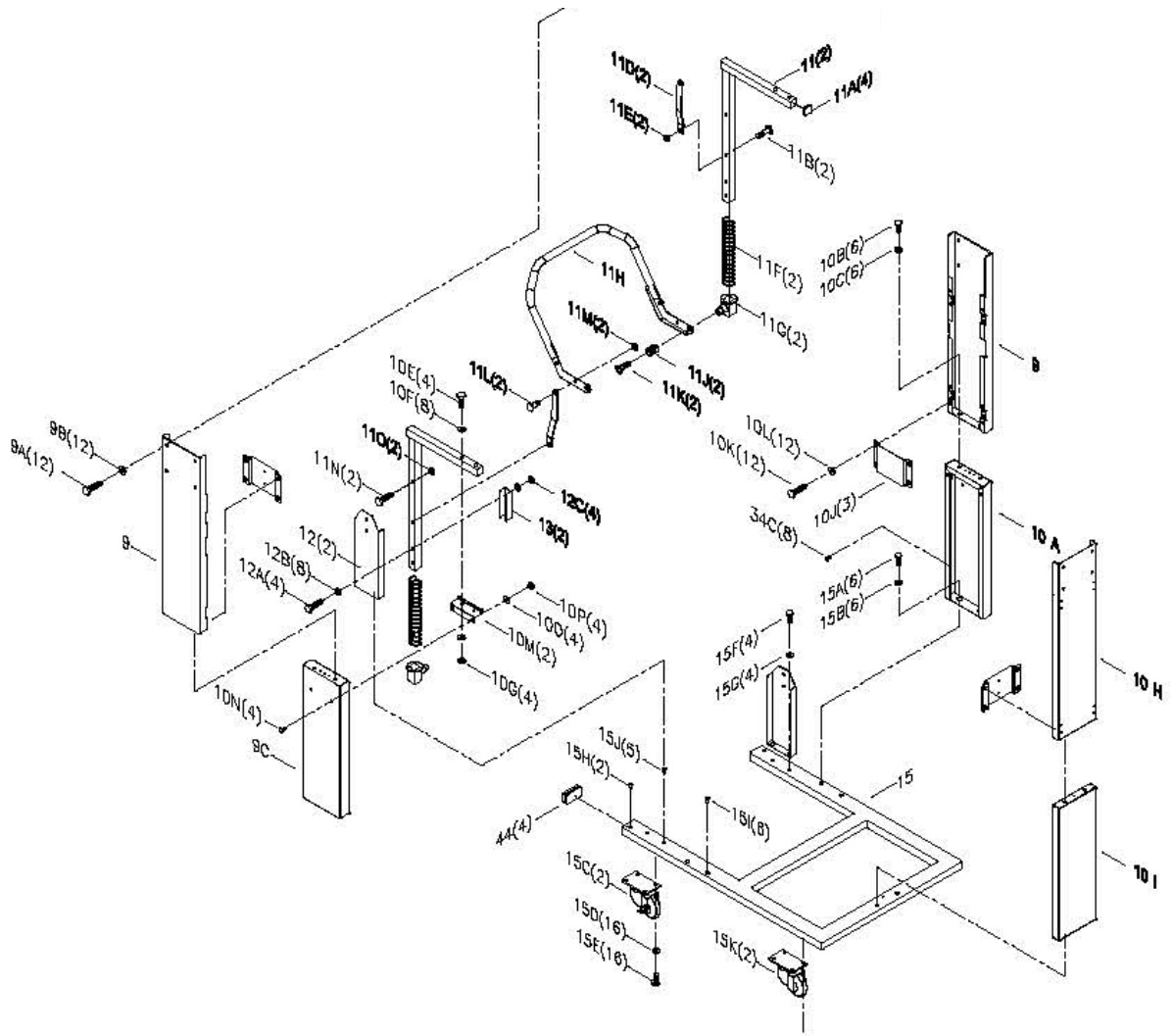

Drum

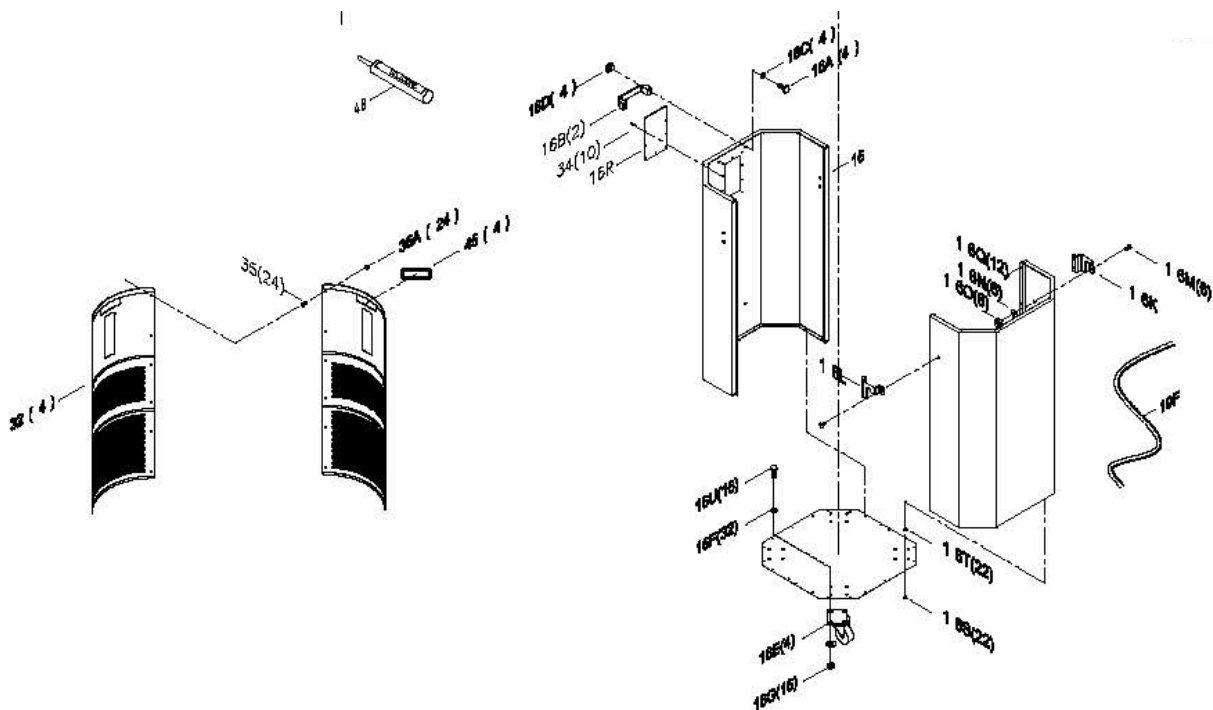

Parts List CFLUX3

No	0BPart Number	Part Name & Description	Q'TY	No	0BPart Number	Part Name & Description	Q'TY
1	PDCCF32201-1	MOTOR 3HP	1	10B	PDCCF32201-10B	HEX BOLT 5/16" x 3/4"	6
1A	PDCCF32201-1A	MOTOR GASKET	1	10C	PDCCF32201-10C	FLAT WASHER 5/16"x18x2t	6
2	PDCCF32201-2	MOTOR SUPPORT BASE	1	10E	PDCCF32201-10E	HEX BOLT 5/16" x 1-3/4"	4
2A	PDCCF32201-2A	HEX LOCK BOLT 5/16" x 5/8"	12	10F	PDCCF32201-10F	FLAT WASHER 5/16"x18x2t	8
2B	PDCCF32201-2B	FLAT WASHER 3/8"x23x2t"	8	10G	PDCCF32201-10G	HEX NUT 5/16"	4
2C	PDCCF32201-2C	HEX BOLT 3/8" x 1"	4	10H	PDCCF32201-10H	TOP UPRIGHT SUPPORT ONE DOT (1A)	1
2D	PDCCF32201-2D	HEX NUT 3/8"	4	10I	PDCCF32201-10IV2	LOWER UPRIGHT SUPPORT ONE DOT (1B) 235V2.2021	1
2E	PDCCF32201-2E	FLAT WASHER 3/8"x23x2mm	4	10J	PDCCF32201-10J	UPRIGHT SUPPORT REINFORCEMENT PLATE	3
2F	PDCCF32201-2F	HEX BOLT 3/8" x 1-1/4"	4	10K	PDCCF32201-10K	HEX BOLT 5/16" x 3/4"	12
2G	PDCCF32201-2G	SWITCH PLATE	1	10L	PDCCF32201-10L	FLAT WASHER 5/16"x18x2mm	12
2H	PDCCF32201-2H	HEX BOLT 1/4" x 3/4"	4	10M	PDCCF32201-10M	FOOT-PEDAL BAR SUPPORT	2
2I	PDCCF32201-2I	FLAT WASHER 1/4"x19x1mm	4	10N	PDCCF32201-10N	CARRIAGE BOLT 5/16"x1/2"	4
3	PDCCF32201-3	FAN 15.5"	1	10O	PDCCF32201-10O	CARRIAGE BOLT 5/16"x18x2mm	4
3A	PDCCF32201-3A	FLAT WASHER 3/8"x45x3t	1	10P	PDCCF32201-10P	HEX NUT 5/16"	4
3B	PDCCF32201-3B	HEX BOLT 3/8" x 1"	1	11	PDCCF32201-11	FOOT PEDDLE BAR	2
6	PDCCF32201-6	DUST CHUTE	1	11A	PDCCF32201-11A	PLUG 25, 25	4
6A	PDCCF32201-6A	CANISTER COVER PLATE	1	11B	PDCCF32201-11B	HEX BOLT 3/8"	2
6B	PDCCF32201-6B	SHEET METAL THREAD BOLT 3/16" x 1/2"	12	11D	PDCCF32201-11D	MOVEABLE SUPPORT BRACE	2
8	PDCCF32201-8	COVER PLATE	1	11E	PDCCF32201-11E	HEX LOCK NUT 3/8"	2
8A	PDCCF32201-8A	SHEET METAL THREAD BOLT M4x12mm	4	11F	PDCCF32201-11F	SPRING Ø42mm x 242mm	2
9	PDCCF32201-9V2	TOP UPRIGHT SUPPORT V2.2021	2	11G	PDCCF32201-11G	SKID BLOCK	2
9A	PDCCF32201-9A	HEX BOLT 5/16" x 3/4"	12	11H	PDCCF32201-11H	OCTAGON DRUM FOOT-PEDAL	1
9B	PDCCF32201-9A	FLAT WASHER 5/16"x18x2mm	12	11J	PDCCF32201-11J	TOPPING Ø24mmx30mm	2
9C	PDCCF32201-9CV2	LOWER UPRIGHT SUPPORT TWO DOT (3B)235 V2.2021	1	11K	PDCCF32201-11K	HEX BOLT M8 x 30mm	2
10A	PDCCF32201-10AV2	LOWER UPRIGHT SUPPORT THREE DOT (2B) 235 V2.2021	1	11L	PDCCF32201-11L	HEX BOLT 3/8"	2
11M	PDCCF32201-11M	HEX LOCK NUT 3/8"	2	16E	PDCCF32201-16E	DRUM CASTER 3"	4
11N	PDCCF32201-11N	HEX BOLT 3/8" x 1-1/2"	2	16U	PDCCF32201-16U	HEX BOLT 5/16" x 3/4"	16
11O	PDCCF32201-11O	HEX LOCK NUT 3/8"	2	16F	PDCCF32201-16F	FLAT WASHER 5/16"x18x2mm	32
12	PDCCF32201-12V2	TRIANGULAR SUPPORT PLATE V2.2021	2	16G	PDCCF32201-16G	HEX NUT 5/16"	16
12A	PDCCF32201-12A	HEX BOLT 5/16" x 1-3/4"	4	16H	PDCCF32201-16HV2	OCTAGON DRUM BACK PANEL V2.2021	1
12B	PDCCF32201-12B	FLAT WASHER 5/16"x18x2mm	8	16K	PDCCF32201-16K	LEFT SIDE PLATE	1
12C	PDCCF32201-12C	HEX NUT 5/16"	4	16L	PDCCF32201-16L	RIGHT SIDE PLATE	1
13	PDCCF32201-13	LOWER SUPPORT PLATE	2	16M	PDCCF32201-16M	CARRIAGE BOLT 1/4" x 1/2"	6

14	PDCCF32201-14V2	PLASTIC BAG Ø610 x 1200mm	3	16N	PDCCF32201-16N	FLAT WASHER 1/4"x19x2mm	6
No	Part Name	Description	Q'TY	No	Part Name	Description	Q'TY
15	PDCCF32201-15	BASE	1	16O	PDCCF32201-16O	HEX NUT 1/4"	6
15A	PDCCF32201-15A	HEX BOLT 3/8" x 3/4"	6	16P	PDCCF32201-16PV2	OCTAGON DRUM BASE PANEL V2.2021	1
15B	PDCCF32201-15B	FLAT WASHER 3/8" x 23 x 2mm	6	16R	PDCCF32201-16RV2	WINDOW V2.2021	1
15C	PDCCF32201-15C	SWIVEL CASTER 4"	2	16S	PDCCF32201-16S	M4 SHEET METAL SCREW	22
15D	PDCCF32201-15D	FLAT WASHER 5/16"x18x2mm	16	16T	PDCCF32201-16T	PLASTIC BOLT END CAP	22
15E	PDCCF32201-15E	HEX BOLT 5/16" x 3/4"	16	16Q	PDCCF32201-16Q	THREAD BOLT M4 x 12mm	10
15F	PDCCF32201-15F	HEX BOLT 5/16" x 3/4"	4	17	PDCCF32201-17	INTAKE CYLINDER	1
15G	PDCCF32201-15G	FLAT WASHER 5/16"x18x2mm	4	17A	PDCCF32201-17A	HEX BOLT 5/16" x 5/8"	4
15H	PDCCF32201-15H	RIVET NUT 1/4"	2	17B	PDCCF32201-17B	FLAT WASHER 5/16"x18x2mm	4
15I	PDCCF32201-15I	RIVET NUT 3/8"	6	18	PDCCF32201-18	CYCLONE BARREL	1
15J	PDCCF32201-15J	RIVET NUT 5/16"	5	18A	PDCCF32201-18A	HEX BOLT 5/16" x 3/4"	12
15K	PDCCF32201-15K	SWIVEL CASTER W/BRAKES 4"	2	18B	PDCCF32201-18B	FOAM TAPE 3 x 6mm x 10M	1
16	PDCCF32201-16V2	OCTAGON DRUM FRONT PANEL V2.2021	1	18D	PDCCF32201-18D	CYCLONE FUNNEL	1
16A	PDCCF32201-16A	FLAT HEAD PHILIP BOLT 5/16"x3/4"	4	18E	PDCCF32201-18E	FLAT WASHER 5/16"x18x2mm	12
16B	PDCCF32201-16B	HANDLE	2	18F	PDCCF32201-18F	HEX BOLT 5/16" x 3/4"	12
16C	PDCCF32201-16C	FLAT WASHER 5/16"x23x2mm	4	18G	PDCCF32201-18G	FLAT WASHER 5/16"x18x2mm	24
16D	PDCCF32201-16D	HEX NUT 5/16"	4	18H	PDCCF32201-18H	HEX NUT 5/16"	12
18J	PDCCF32201-18J	FOAM TAPE 3x15mm x 80CM	1	23H	PDCCF32201-23H	FLAT WASHER 5/16"x 18x 2mm	2
19	PDCCF32201-19V2	OCTAGON DRUM LID V2.2021	1	23I	PDCCF32201-23I	HEX LOCK NUT 5/16"	1
19A	PDCCF32201-19A	HEX BOLT 5/16" x 3/4"	6	24	PDCCF32201-24	CANISTER FILTER Ø400mm x 900mm	1
19B	PDCCF32201-19B	FLAT WASHER 5/16"x18x2mm	12	24A	PDCCF32201-24A	ROTATION SHAFT BASE	1
19C	PDCCF32201-19C	HEX NUT 5/16"	6	24B	PDCCF32201-24B	SHEET METAL PHILIP BOLT 3/16" x 3/4"	4
19D	PDCCF32201-19D	PLUG MSP-16	1	24C	PDCCF32201-24C	HEX BOLT 5/16" x 3/4"	1
19E	PDCCF32201-19E	NUT AGL-16	1	24D	PDCCF32201-24D	FLAT WASHER 5/16" x 23 x 2mm	1
19F	PDCCF32201-19F	RUBBER GASKET 1650mm	1	24E	PDCCF32201-24E	FOAM TAPE 3 x 25mm x 1.5M	1
20	PDCCF32201-20	BAND CLAMP Ø400mm	1	25	PDCCF32201-25	PLASTIC BAG Ø400mm x 600mm	3
20A	PDCCF32201-20A	SPRING BAND CLAMP Ø400mm	1				
22	PDCCF32201-22	ROTATION CRANK	1	27A	PDCCF32201-27A	SHEET METAL BOLT M4 x 12mm	3
22A	PDCCF32201-22A	HEX BOLT 5/16" x 3/4"	1				
22B	PDCCF32201-22B	FLAT WASHER 5/16"x30x3mm	1	27C	PDCCF32201-27C	INTAKE SPLITTER 8" x 4" X 3	1
22C	PDCCF32201-22C	GEAR Ø20mm	1	32	PDCCF32201-32V2	DRUM INSERT V2.2021	4
22D	PDCCF32201-22D	HEX BOLT 1/4" x 3/4"	4	33	PDCCF32201-33	FLAT HEAD BOLT M4 x 6mm	4

22E	PDCCF32201-22E	FLAT WASHER 1/4" x 19 x 2mm	4	34	PDCCF32201-34	RIVET 3-2	10
No	Part Name	Description	Q'TY	No	Part Name	Description	Q'TY
22F	PDCCF32201-22F	BEARING	1	34C	PDCCF32201-34C	RIVET NUT 1/4"	8
22G	PDCCF32201-22G	SEAL	1	34D	PDCCF32201-34D	RIVET NUT 5/16"	18
23	PDCCF32201-23V2	ROTATION SHAFT V2.2021	1	35	PDCCF32201-35	ROUND HD BOLT 3/16" x 1/2"	24
23A	PDCCF32201-23A	HEX BOLT 1/4" x 5/8"	8	35A	PDCCF32201-35A	NUT 3/16"	24
23B	PDCCF32201-23B	FLAT WASHER 1/4" x 13 x 1mm	16	36	PDCCF32201-36V2	FREQUENCY REMOTE SWITCH V2.2021	1
23C	PDCCF32201-23C	PADDLE	2	44	PDCCF32201-44	RUBBER PLUG 30mm x 60mm	4
23D	PDCCF32201-23D	PADDLE BRANCH	4	47	PDCCF32201-47	CROSSBAR	1
23E	PDCCF32201-23E	HEX LOCK NUT 1/4"	8	48	PDCCF32201-48	SILICONE	1
23F	PDCCF32201-23F	ROTATION SHAFT CONNECTION	1				
23G	PDCCF32201-23G	HEX BOLT 5/16" x 1-1/2"	1				